



Pneumatic cylinders

Profile cylinders series P1K

*Catalogue PDE2577TCUK-ul
December 2006*



Features	Air cylinder	Hydraulic cylinder	Electro mechanical actuators
Overload safe	***	***	*
Easy to limit force	***	***	*
Easy to vary speed	***	***	*
Speed	***	**	**
Reliability	***	***	***
Robustness	***	***	*
Installation cost	***	*	**
Ease of service	***	**	*
Safety in damp environments	***	***	*
Safety in explosive atmospheres	***	***	*
Safety risk with electrical installations	***	***	*
Risk of oil leak	***	*	***
Clean, hygienic	***	**	*
Standardised measurements	***	***	*
Service life	***	***	*
Hydraulic system required	***	*	***
Weight	**	**	**
Purchase price	***	**	*
Power density	**	***	*
Noise level during operation	**	***	**
High force for size	**	***	*
Positioning possibilities	*	***	***
Total energy consumption	*	**	***
Service interval	*	**	***
Compressor capacity required	*	***	***

* = good, **=average, ***=excellent



Important
 Before attempting any external or internal work on the cylinder or any connected components, make sure the cylinder is vented and disconnect the air supply in order to ensure isolation of the air supply.



Note
 All technical data in this catalogue are typical data only.
 Air quality is essential for maximum cylinder service life (see ISO 8573).



WARNING

FAILURE OR IMPROPER SELECTION OR IMPROPER USE OF THE PRODUCTS AND/OR SYSTEMS DESCRIBED HEREIN OR RELATED ITEMS CAN CAUSE DEATH, PERSONAL INJURY AND PROPERTY DAMAGE.

This document and other information from Parker Hannifin Corporation, its subsidiaries and authorized distributors provide product and/or system options for further investigation by users having technical expertise. It is important that you analyze all aspects of your application and review the information concerning the product or system in the current product catalog. Due to the variety of operating conditions and applications for these products or systems, the user, through its own analysis and testing, is solely responsible for making the final selection of the products and systems and assuring that all performance, safety and warning requirements of the application are met. The products described herein, including without limitation, product features, specifications, designs, availability and pricing, are subject to change by Parker Hannifin Corporation and its subsidiaries at any time without notice.

SALE CONDITIONS

The items described in this document are available for sale by Parker Hannifin Corporation, its subsidiaries or its authorized distributors. Any sale contract entered into by Parker will be governed by the provisions stated in Parker's standard terms and conditions of sale (copy available upon request).

Contents	Page
P1K profile cylinders, general	4
Cylinder forces	6
Operation data	6
Working medium, air quality	6
Main data: P1K	7
Material specifications.....	7
Guide for selecting suitable tubing	8
Order key.....	10
Standard stroke length in mm	10
Order code standard stroke double-acting.....	11
Order code standard stroke single-acting, spring return.....	12
Complete working unit.....	13
Order key, special versions	14-15
Dimensions.....	16-17
Mountings.....	18-22
Tightening torques	23
Seal kits for complete P1K cylinder	23
Grease for P1K	23

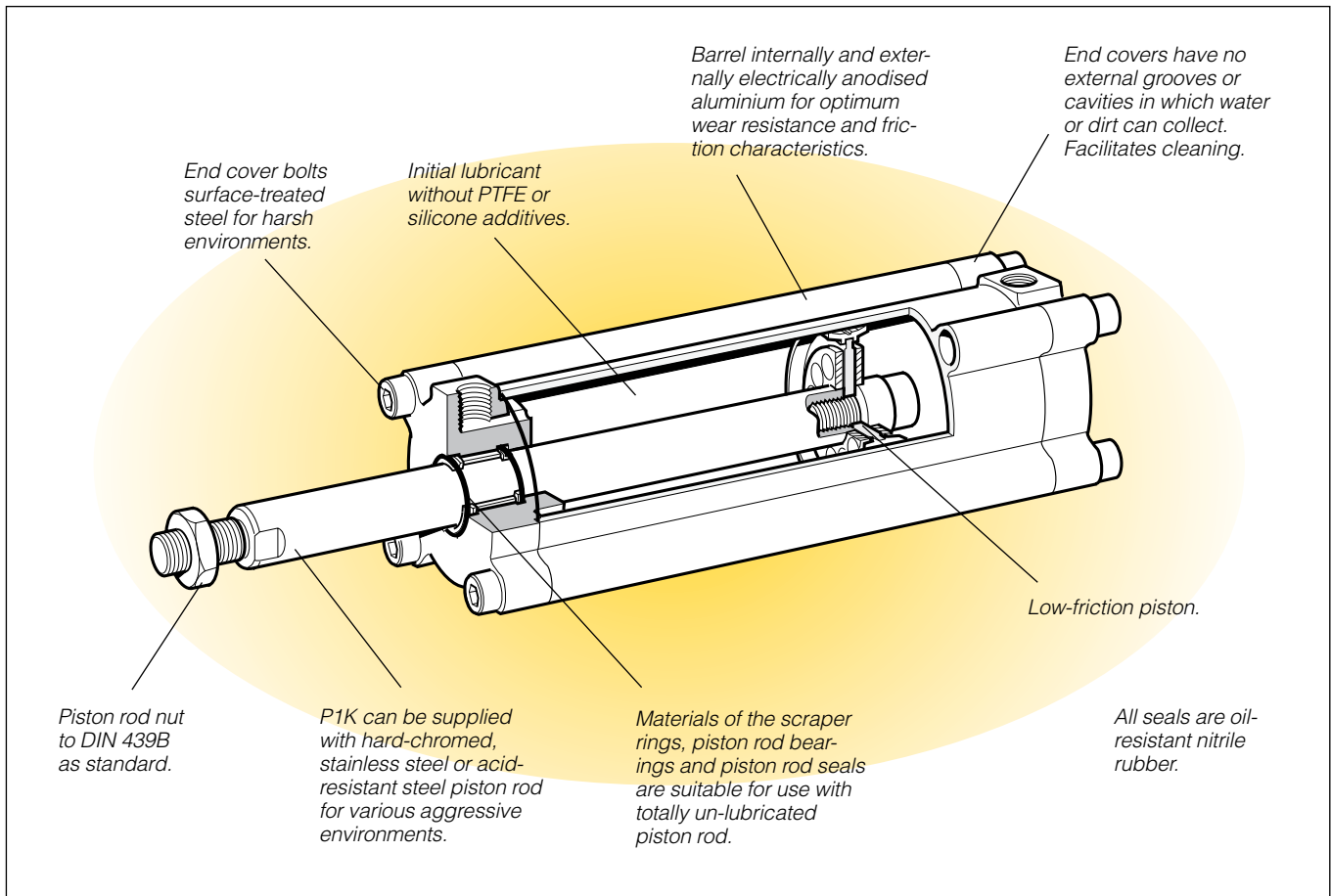

P1K profile cylinders

The Parker P1K series cylinders are double acting with fixed end cushioning for light duty applications. The range is based upon the international ISO 6431 standard, but with considerably shorter overall length. They are available in bore sizes 32-125 mm with standard stroke lengths, 25-320 mm.

A complete range of mountings is available to suit the numerous application requirements, however, if required, the cylinders can be directly mounted using the existing end cover bolts.

The end plates and aluminium tube have the same profile, eliminating pockets or grooves where dirt could collect, the smooth clean surfaces meet strict hygienic requirements.

P1K cylinders are pre-lubricated during assembly and under normal operating conditions require no further lubrication. To ensure long life, particularly in applications where initial piston rod lubrication may be washed off, for example with detergents, the rod wiper and neck seal are manufactured from lubricant impregnated polythene.

The cylinder is available as a single-acting spring return version with strokes of 25 or 50 mm depending upon bore size.

A range of special cylinders to suit various applications can be produced from the basic P1K unit.

Clean design for foodstuffs applications

The clean design with end plates that precisely line up with the unique housing tube profile means that a lot of P1K cylinders are used in the foodstuffs industry. With a few adaptations, such as fully anodised end plate screws, the P1K is the perfect cylinder for cheesemaking equipment.

The fully anodised cylinders, with their hygienic, easily cleaned design, are installed vertically and press the whey out of the curds. This is an example of where the P1K offers decisive advantages for applications where hygiene and cleanliness are important requirements.

Complete working Unit

The P1K series cylinders are available with factory fitted control valve complete with pipework and fittings, the compact assembly enables use in confined spaces and applications where high speed actuation is important, see page 13.

Cushioning

The P1K range of cylinders incorporate fixed end cushioning suitable for lighter duty applications. If used for high loads, provision should be made for external stops and damping. The high and low temperature versions are not available with cushioning.

Clean external design

The end plates of P1K cylinders have no recesses or cavities; this prevents retention of dirt or liquids and enables simple and effective cleaning.

Corrosion resistance

The selection of materials and surface treatments ensure that even standard versions of the P1K cylinder have good corrosion resistance and make them suitable for applications in demanding environments.

Dry Operation

The design of the cylinder makes it ideal for applications demanding hygiene and regular cleaning. Use of pre-lubricated materials together with the design of piston rod bearing, scraper and seal enable regular wiping/de-greasing of the piston rod without jeopardising the service life.

Mountings

A complete range of corrosion resistant mountings is available.

Options

In addition to the standard version, the P1K cylinder is available with various options depending upon the basic model selected.

- Non standard stroke lengths
- Choice of piston rod materials
- Extended piston rods
- Through piston rod
- End cap screws in stainless steel
- Single acting
- Complete assembly with control valve

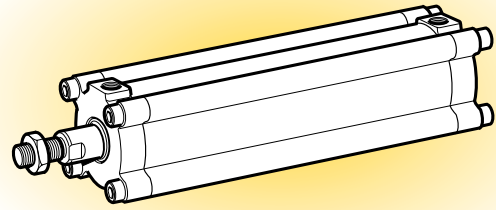

Double acting

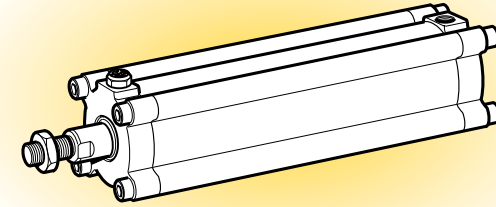

Single acting

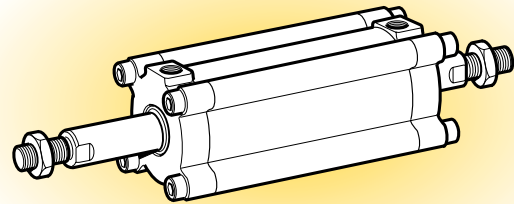

Double acting with through piston rods

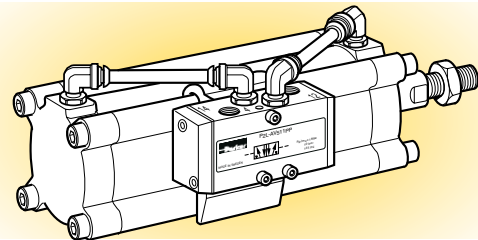

Double acting with a mounted valve

Cylinder forces, double acting variants

Cyl. bore/ pist. rod mm	Stroke	Pistonarea cm ²	Max theoretical force in N (bar)									
			1,0	2,0	3,0	4,0	5,0	6,0	7,0	8,0	9,0	10,0
32/12	+	8,0	80	161	241	322	402	483	563	643	724	804
	-	6,9	69	138	207	276	346	415	484	553	622	691
40/16	+	12,6	126	251	377	503	628	754	880	1005	1131	1257
	-	10,6	106	212	318	424	530	636	742	848	954	1060
50/20	+	19,6	196	393	589	785	982	1178	1374	1571	1767	1963
	-	16,5	165	330	495	660	825	990	1155	1319	1484	1649
63/20	+	31,2	312	623	935	1247	1559	1870	2182	2494	2806	3117
	-	28,0	280	561	841	1121	1402	1682	1962	2242	2523	2803
80/25	+	50,3	503	1005	1508	2011	2513	3016	3519	4021	4524	5027
	-	45,4	454	907	1361	1814	2268	2721	3175	3629	4082	4536
100/32	+	78,5	785	1571	2356	3142	3927	4712	5498	6283	7069	7854
	-	70,5	705	1410	2115	2820	3525	4230	4935	5640	6345	7050
125/32	+	122,7	1227	2454	3682	4909	6136	7363	8590	9817	11045	12272
	-	114,7	1147	2294	3440	4587	5734	6881	8027	9174	10321	11468

+ = Outward stroke
- = Return stroke

Note!
Select a theoretical force 50-100% larger than the force required

Operation data

Working pressure	Max 10 bar	
Working temperature	min	max
Standard	-20 °C	+80 °C
High temp version	-10 °C	+150 °C
Low temp version	-40 °C	+40 °C

Greased for life, does not normally need additional lubrication. If extra lubrication is given, this must always be continued.

Working medium, air quality

Working medium Dry, filtered compressed air to ISO 8573-1 class 3.4.3.

Recommended air quality for cylinders

For best possible service life and trouble-free operation, ISO 8573-1 quality class 3.4.3 should be used. This means 5 µm filter (standard filter) dew point +3 °C for indoor operation (a lower dew point should be selected for outdoor operation) and oil concentration 1.0 mg oil/m³, which is what a standard compressor with a standard filter gives.

ISO 8573-1 quality classes

Quality class	Pollution		Water max. press. dew point (°C)	Oil max concentration (mg/m ³)
	particle size (µm)	max concentration (mg/m ³)		
1	0,1	0,1	-70	0,01
2	1	1	-40	0,1
3	5	5	-20	1,0
4	15	8	+3	5,0
5	40	10	+7	25
6	-	-	+10	-



Important!

When the cylinders are used in applications with heavy side loading on the piston rod, an outer guide must be used to ensure maximum service life.

Main data

Cylinder designation	Cylinder Piston rod					Total mass at 0 mm stroke length kg	Mass, moving parts		Air consumption litre	Port size	
	bore	area	diam.	area	thread		Addition per 10 mm stroke kg	at 0 mm stroke length kg			
	mm	cm ²	mm	cm ²							
Double acting											
P1K-S032DA-XXXX ¹⁾	32	8,0	12	1,1	M10x1,25	0,33	0,024	0,09	0,009	0,105 ²⁾	1/8
P1K-S040DA-XXXX ¹⁾	40	12,6	16	2,0	M12x1,25	0,48	0,032	0,14	0,016	0,162 ²⁾	1/8
P1K-S050DA-XXXX ¹⁾	50	19,6	20	3,1	M16x1,5	0,70	0,049	0,26	0,025	0,253 ²⁾	1/8
P1K-S063DA-XXXX ¹⁾	63	31,2	20	3,1	M16x1,5	1,04	0,058	0,31	0,025	0,414 ²⁾	1/8
P1K-S080DA-XXXX ¹⁾	80	50,0	25	4,9	M20x1,5	1,75	0,081	0,56	0,039	0,669 ²⁾	1/4
P1K-S100DA-XXXX ¹⁾	100	79,0	32	8,0	M20x1,5	2,48	0,116	0,86	0,063	1,043 ²⁾	1/4
P1K-S125DA-XXXX ¹⁾	125	123,0	32	8,0	M27x2	4,35	0,138	1,77	0,063	1,662 ²⁾	3/8
Single acting											
P1K-S032SA-0025	32	8,0	12	1,1	M10x1,25	0,48 ³⁾		0,15 ³⁾		0,141 ³⁾	1/8
P1K-S032SA-0050	32	8,0	12	1,1	M10x1,25	0,60 ³⁾		0,27 ³⁾		0,282 ³⁾	1/8
P1K-S040SA-0025	40	12,6	16	2,0	M12x1,25	0,67 ³⁾		0,24 ³⁾		0,220 ³⁾	1/8
P1K-S040SA-0050	40	12,6	16	2,0	M12x1,25	0,84 ³⁾		0,32 ³⁾		0,440 ³⁾	1/8
P1K-S050SA-0025	50	19,6	20	3,1	M16x1,5	1,02 ³⁾		0,44 ³⁾		0,344 ³⁾	1/8
P1K-S050SA-0050	50	19,6	20	3,1	M16x1,5	1,27 ³⁾		0,57 ³⁾		0,688 ³⁾	1/8
P1K-S063SA-0025	63	31,2	20	3,1	M16x1,5	1,41 ³⁾		0,51 ³⁾		0,546 ³⁾	1/8
P1K-S063SA-0050	63	31,2	20	3,1	M16x1,5	1,72 ³⁾		0,63 ³⁾		1,092 ³⁾	1/8
P1K-S080SA-0050	80	50,0	25	4,9	M20x1,5	2,81 ³⁾		1,13 ³⁾		1,760 ³⁾	1/4
P1K-S100SA-0050	100	79,0	32	8,0	M20x1,5	3,99 ³⁾		1,74 ³⁾		2,748 ³⁾	1/4

1) XXXX=stroke length. 2) Free air consumption per 100 mm stroke length for a double stroke at 6 bar. 3) At the relevant stroke length.

Piston forces

The values for piston forces are theoretical and should be reduced to suit working conditions.

Cylinder designation	Theoretical piston force at 6 bar Plus stroke		Spring force	
	Nmax	Nmin	Minus stroke Nmax	Nmin
Single acting				
P1K-S032SA-0025	450	441	30	39
P1K-S032SA-0050	450	432	30	48
P1K-S040SA-0025	714	704	40	50
P1K-S040SA-0050	714	688	40	50
P1K-S050SA-0025	1120	1101	60	79
P1K-S050SA-0050	1120	1090	60	90
P1K-S063SA-0025	1800	1782	70	88
P1K-S063SA-0050	1800	1771	70	99
P1K-S080SA-0050	2925	2878	95	142
P1K-S100SA-0050	4570	4518	140	192

Material specifications

Cylinder barrel	Anodised aluminium
End covers	Anodised aluminium
End cap screws	Galvanized steel
Piston	Steel/Nitrile rubber, NBR
Piston rod bearing	Acetal plastic/Bronze/Steel
Piston rod	Stainless steel X 10 CrNiS 18 9
Scraper ring, piston rod sealing	UHMWPE-plastic
Cushioning ring	Polyurethane
Other sealings	Nitrile rubber, NBR
Return spring	stainless spring steel

Option

Piston rod material	Hard-chromium plated steel, Fe 490-2 FN Acid-proof steel, X 5 CrNiMo 17 13 3 Hard-chromium plated stainless steel, X 10 CrNiS 18 9
---------------------	---

Guide for selecting suitable tubing

The selection of the correct size of tubing is often based on experience, with no great thought to optimizing energy efficiency and cylinder velocity. This is usually acceptable, but making a rough calculation can result in worthwhile economic gains.

The following is the basic principle:

1. The primary line to the working valve could be over sized (this does not cause any extra air consumption and consequently does not create any extra costs in operation).
2. The tubes between the valve and the cylinder should, however, be optimized according to the principle that an insufficient bore throttles the flow and thus limits the cylinder speed, while an oversized pipe creates a dead volume which increases the air consumption and filling time.

The chart below is intended to help when selecting the correct size of tube to use between the valve and the cylinder.

The following prerequisites apply:

The cylinder load should be about 50% of the theoretical force (= normal load). A lower load gives a higher velocity and vice versa. The tube size is selected as a function of the cylinder bore, the desired cylinder velocity and the tube length between the valve and the cylinder.

If you want to use the capacity of the valve to its maximum, and obtain maximum speed, the tubing should be chosen so that they at least correspond with the equivalent restriction diameter (see description below), so that the tubing does not restrict the total flow. This means that a short tubing must have at least the equivalent restriction diameter. If the tubing is longer, choose it from the table below. Straight fittings should be chosen for highest flow rates. (Elbow and banjo fittings cause restriction.)

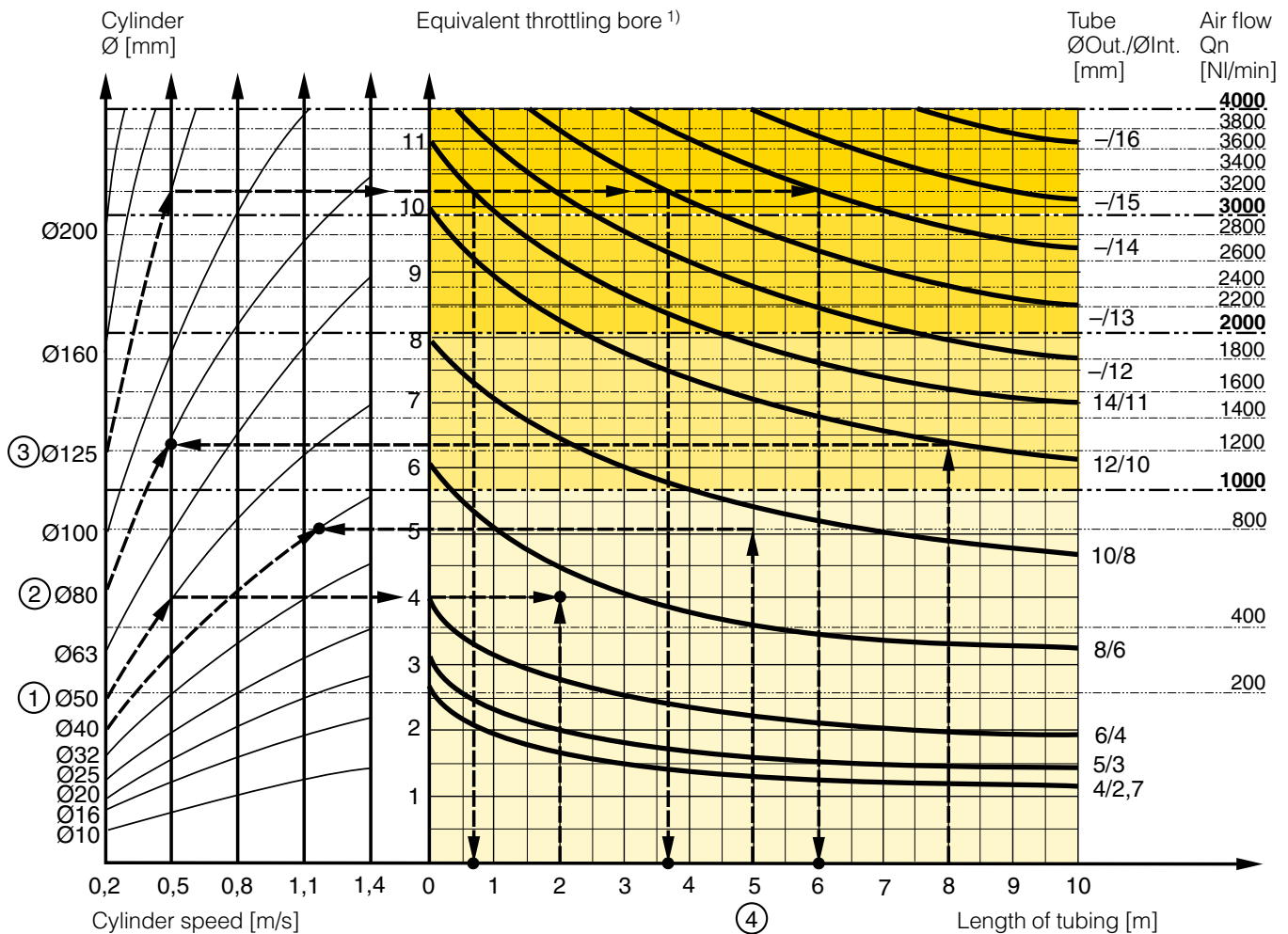

- 1) The “equivalent throttling bore” is a long throttle (for example a tube) or a series of throttles (for example, through a valve) converted to a short throttle which gives a corresponding flow rate. This should not be confused with the “orifice” which is sometimes specified for valves. The value for the orifice does not normally take account of the fact that the valve contains a number of throttles.
- 2) Qn is a measure of the valve flow capacity, with flow measured in litre per minute (l/min) at 6 bar(e) supply pressure and 1 bar pressure drop across the valve.

Example ①: Which tube diameter should be used?

A 50 mm bore cylinder is to be operated at 0.5 m/s. The tube length between the valve and cylinder is 2 m. In the diagram we follow the line from 50 mm bore to 0.5 m/s and get an "equivalent throttling bore" of approximately 4 mm. We continue out to the right in the chart and intersect the line for a 2 m tube between the curves for 4 mm (6/4 tube) and 6 mm (8/6 tube). This means that a 6/4 tube throttles the velocity somewhat, while an 8/6 tube is a little too large. We select the 8/6 tube to obtain full cylinder velocity.

Example ②: What cylinder velocity will be obtained?

A 80 mm bore cylinder will be used, connected by 8 m 12/10 tube to a P2L-B valve. What cylinder velocity will we get? We refer to the diagram and follow the line from 8 mm tube length up to the curve for 12/10 tube. From there, we go horizontally to the curve for the Ø80 cylinder. We find that the velocity will be about 0.5 m/s.

Example ③: What is the minimum inner diameter and maximum length of tube?

For an application a 125 mm bore cylinder will be used. Maximum velocity of piston rod is 0.5 m/s. The cylinder will be controlled by a P2L-D valve. What diameter of tube can be used and what is maximum length of tube. We refer to the diagram. We start at the left side of the diagram cylinder Ø125. We follow the line until the intersection with the velocity line of 0.5 m/s. From here we draw a horizontal line in the diagram. This line shows us we need an equivalent throttling bore of approximately 10 mm. Following this line horizontally we cross a few intersections. These intersections show us the minimum inner diameter (rightside diagram) in combination with the maximum length of tube (bottomside diagram).

For example:

Intersection one: When a tube (14/11) will be used, the maximum length of tube is 0.7 meter.

Intersection two: When a tube (—/13) will be used, the maximum length of tube is 3.7 meter.

Intersection three: When a tube (—/14) will be used, the maximum length of tube is 6 meter.

Example ④: Determining tube size and cylinder velocity with a particular cylinder and valve?

For an application using a 40 mm bore cylinder with a valve with Qn=800 NI/min. The distance between the cylinder and valve has been set to 5 m.

Tube dimension: What tube bore should be selected to obtain the maximum cylinder velocity? Start at pipe length 5 m, follow the line up to the intersection with 800 NI/min. Select the next largest tube diameter, in this case Ø10/8 mm.

Cylinder velocity: What maximum cylinder velocity will be obtained? Follow the line for 800 NI/min to the left until it intersects with the line for the Ø40 mm cylinder. In this example, the speed is just above 1.1 m/s.

Valve series with respective flows in NI/minute

Valve series	Qn in NI/Min
Valvetronic Solstar	33
Interface PS1	100
Adex A05	173
Moduflex size 1, (2 x 3/2)	220
Valvetronic PVL-B 5/3 closed centre, 6 mm push in	290
Moduflex size 1, (4/2)	320
B43 Manual and mechanical	340
Valvetronic PVL-B 2 x 2/3, 6 mm push in	350
Valvetronic PVL-B 5/3 closed centre, G1/8	370
Compact Isomax DX02	385
Valvetronic PVL-B 2 x 3/2 G1/8	440
Valvetronic PVL-B 5/2, 6 mm push in	450
Valvetronic PVL-B 5/3 vented centre, 6 mm push in	450
Moduflex size 2, (2 x 3/2)	450
Flowstar P2V-A	520
Valvetronic PVL-B 5/3 vented centre, G1/8	540
Valvetronic PVL-B 5/2, G1/8	540
Valvetronic PVL-C 2 x 3/2, 8 mm push in	540
Adex A12	560
Valvetronic PVL-C 2 x 3/2 G1/8	570
Compact Isomax DX01	585
Valvetronic PVL-C 5/3 closed centre, 8 mm push in	700
Valvetronic PVL-C 5/3 vented centre, G1/4	700
VIKING P2L-A	760
B3 Series	780
Valvetronic PVL-C 5/3 closed centre, G1/4	780
Moduflex size 2, (4/2)	800
Valvetronic PVL-C 5/2, 8 mm push in	840
Valvetronic PVL-C 5/3 vented centre, 8 mm push in	840
Valvetronic PVL-C 5/2, G1/4	840
VIKING P2L-B	1020
Flowstar P2V-B	1090
ISOMAX DX1	1150
B53 Manual and mechanical	1160
B4 Series	1170
Airline Isolator Valve VE22/23	1470
ISOMAX DX2	2330
VIKING P2L-D	2880
ISOMAX DX3	4050
Airline Isolator Valve VE42/43	5520
Airline Isolator Valve VE82/83	13680

NOTE!

P1K cylinders are equipped with damping cushions, and are therefore designed to reach the following reduced maximum speeds.

Max speed for diameters 3, 40 and 50 mm is 1.1 m/s

Max speed for diameter 63 mm is 0.8 m/s

Max speed for diameters 80, 100 and 150 mm is 0.6 m/s

Order key

P1K	-	S	032	D	A	-	0100																						
Cyl. bore mm		Cylinder type/Function			Stroke (mm) E.g. 0025 = 25 mm																								
<table border="1" style="width: 100%; border-collapse: collapse;"> <tr><td style="text-align: center;">032</td></tr> <tr><td style="text-align: center;">040</td></tr> <tr><td style="text-align: center;">050</td></tr> <tr><td style="text-align: center;">063</td></tr> <tr><td style="text-align: center;">080</td></tr> <tr><td style="text-align: center;">100</td></tr> <tr><td style="text-align: center;">125</td></tr> </table>		032	040	050	063	080	100	125	<table border="1" style="width: 100%; border-collapse: collapse;"> <tr><td style="text-align: center;">D</td><td></td><td>Double acting</td></tr> <tr><td style="text-align: center;">K</td><td></td><td>Double acting through rod</td></tr> <tr><td style="text-align: center;">S</td><td></td><td>Single acting spring return</td></tr> <tr><td style="text-align: center;">B</td><td></td><td>Double acting Pin screws and nuts in rear end cover</td></tr> <tr><td style="text-align: center;">A</td><td></td><td>Double acting End cover screws in stainless steel</td></tr> </table>			D		Double acting	K		Double acting through rod	S		Single acting spring return	B		Double acting Pin screws and nuts in rear end cover	A		Double acting End cover screws in stainless steel	<p>For standard stroke length and max length, see table below</p>		
032																													
040																													
050																													
063																													
080																													
100																													
125																													
D		Double acting																											
K		Double acting through rod																											
S		Single acting spring return																											
B		Double acting Pin screws and nuts in rear end cover																											
A		Double acting End cover screws in stainless steel																											
Material piston rod				Type of sealing																									
Stainless steel	Hard chromed steel	Acid-proof steel	Chromed stainl. steel	Standard -20 °C to +80 °C																									
A	T	X	1																										
* Piston rod with female thread, please contact customer service.																													

Standard stroke length in mm

Cylinder design. XXXX = Stroke	Cylinder bore (mm)	● Standard stroke length (mm)								■ Non standard stroke length									
		25	50	80	100	125	160	200	250	320	400	500	600	700	800	900	2800		
Double acting																			
P1K-S032DA-XXXX	32	●	●	●	●	●	●	●	●									//	//
P1K-S040DA-XXXX	40	●	●	●	●	●	●	●	●									//	//
P1K-S050DA-XXXX	50	●	●	●	●	●	●	●	●									//	//
P1K-S063DA-XXXX	63	●	●	●	●	●	●	●	●									//	//
P1K-S080DA-XXXX	80	●	●	●	●	●	●	●	●									//	//
P1K-S100DA-XXXX	100	●	●	●	●	●	●	●	●									//	//
P1K-S125DA-XXXX	125	●	●	●	●	●	●	●	●									//	//
Single acting spring return																			
P1K-S032SA-XXXX	32	●	●																
P1K-S040SA-XXXX	40	●	●																
P1K-S050SA-XXXX	50	●	●																
P1K-S063SA-XXXX	63	●	●																
P1K-S080SA-XXXX	80	●	●																
P1K-S100SA-XXXX	100	●	●																

Double-acting

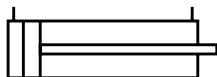
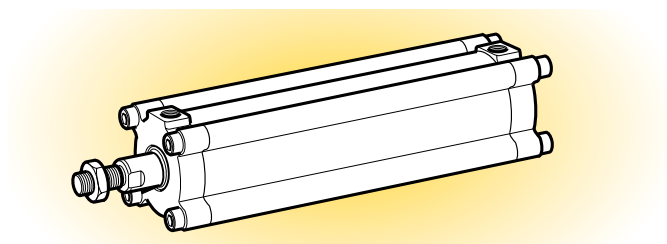

Fixed end cushioning

Cyl. bore mm	Stroke mm	Order code
32 Conn. G1/8	25	P1K-S032DA-0025
	50	P1K-S032DA-0050
	80	P1K-S032DA-0080
	100	P1K-S032DA-0100
	125	P1K-S032DA-0125
	160	P1K-S032DA-0160
	200	P1K-S032DA-0200
	250	P1K-S032DA-0250
40 Conn. G1/8	25	P1K-S040DA-0025
	50	P1K-S040DA-0050
	80	P1K-S040DA-0080
	100	P1K-S040DA-0100
	125	P1K-S040DA-0125
	160	P1K-S040DA-0160
	200	P1K-S040DA-0200
	250	P1K-S040DA-0250
50 Conn. G1/8	25	P1K-S050DA-0025
	50	P1K-S050DA-0050
	80	P1K-S050DA-0080
	100	P1K-S050DA-0100
	125	P1K-S050DA-0125
	160	P1K-S050DA-0160
	200	P1K-S050DA-0200
	250	P1K-S050DA-0250
63 Conn. G1/8	25	P1K-S063DA-0025
	50	P1K-S063DA-0050
	80	P1K-S063DA-0080
	100	P1K-S063DA-0100
	125	P1K-S063DA-0125
	160	P1K-S063DA-0160
	200	P1K-S063DA-0200
	250	P1K-S063DA-0250

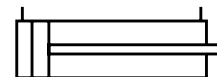

Fixed end cushioning

Cyl. bore mm	Stroke mm	Order code
80 Conn. G1/4	25	P1K-S080DA-0025
	50	P1K-S080DA-0050
	80	P1K-S080DA-0080
	100	P1K-S080DA-0100
	125	P1K-S080DA-0125
	160	P1K-S080DA-0160
	200	P1K-S080DA-0200
	250	P1K-S080DA-0250
100 Conn. G1/4	25	P1K-S100DA-0025
	50	P1K-S100DA-0050
	80	P1K-S100DA-0080
	100	P1K-S100DA-0100
	125	P1K-S100DA-0125
	160	P1K-S100DA-0160
	200	P1K-S100DA-0200
	250	P1K-S100DA-0250
125 Conn. G3/8	25	P1K-S125DA-0025
	50	P1K-S125DA-0050
	80	P1K-S125DA-0080
	100	P1K-S125DA-0100
	125	P1K-S125DA-0125
	160	P1K-S125DA-0160
	200	P1K-S125DA-0200
	250	P1K-S125DA-0250

The cylinders are supplied complete with one zinc plated steel piston rod nut.

Single-acting, spring return

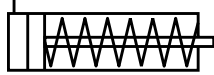
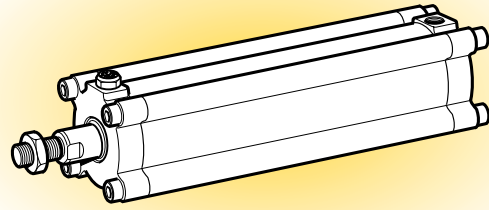

Fixed end cushioning

Cyl. bore mm	Stroke mm	Order code
32		
Conn. G1/8	25	P1K-S032SA-0025
	50	P1K-S032SA-0050
40		
Conn. G1/8	25	P1K-S040SA-0025
	50	P1K-S040SA-0050
50		
Conn. G1/8	25	P1K-S050SA-0025
63		
Conn. G1/8	25	P1K-S063SA-0025
	50	P1K-S063SA-0050
80		
Conn. G1/4	50	P1K-S080SA-0050
100		
Conn. G1/4	50	P1K-S100SA-0050

The cylinders are supplied complete with one zinc plated steel piston rod nut.

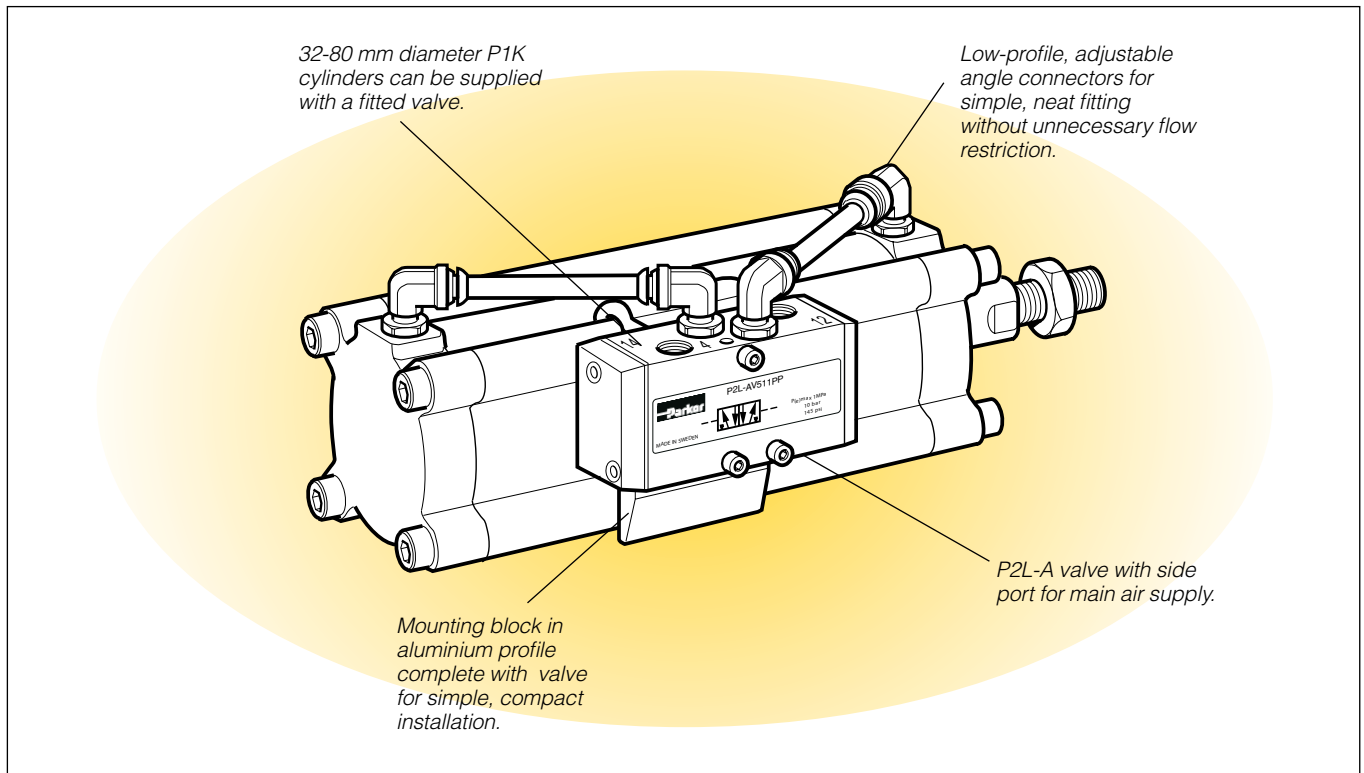

Complete working unit

The P1K series cylinders, 32 to 80 mm bore sizes, are available complete with factory fitted control valve. The valve, type P2L-A, is securely attached to the cylinder profile barrel by means of a mounting plate and includes the valve to cylinder pipework. Installation of the cylinder assembly into the application is completed by use of standard mountings together with cable connections and mains air supply.

Fast response

The short distance between valve and cylinder enable fast response and minimum air restriction.

Maintenance free and easy to service

The complete assembly comprises standard components, with both valve and cylinder suitable for use without additional airline lubrication.

Many applications

The compact assembly enables use in confined spaces and applications where fast actuation is important. This includes applications where the cylinder is remotely located, for example silo plants, damper and process valve actuation and many similar installations.

Solenoid valve voltage

24 V UC (24 V DC/AC, Universal Current)
115 V, 50 Hz, 120 V 60 Hz
230 V, 50 Hz, 240 V 60 Hz

Order specifications, see pages 14 and 15.

Technical data

Working pressure max 10 bar
Working medium dry, filtered compressed air
Working temperature -20 °C to +70 °C
(-15 °C to +60 °C with solenoid valve)
Flow, P2L-A, acc. to ISO 6358 C=3,0 NI/s, bar, b= 0,3

Power consumption, solenoid	Inrush	Hold
P2E-KV32C1, 24 V DC	1,2 W	1,2 W
P2E-KV31C1, 24 V AC	3,5 VA	1,6 VA

Material specification

P1K cylinders	see page 7.
P2L-A- valves	
Valve body and end covers	Anodised aluminium
See also catalogue: Viking P2L valves	
P2E-•V solenoid valves	
Body, coil casing	Thermoplastic
Coil	Epoxy moulded
Mounting plate	Anodised aluminium
Mounting screws for plate	Stainless steel
Mounting screws for valve	Zinc-plated steel
Elbow fittings	Nickel-plated brass/plastic

Accessories

Description	Order code
Silencer (Siflow) for P2L-A valve, G1/8	9301050901
Silencer (sintered plastic) for P2L-A valve, G1/8	P6M-PAB1
Mounting plate P2L-A P1K- Ø32, Ø40	9122520050
Mounting plate P2L-P1K- Ø50, Ø63	9122520051
Mounting plate P2L-A P1K- Ø80	9122520052

Order key, special versions

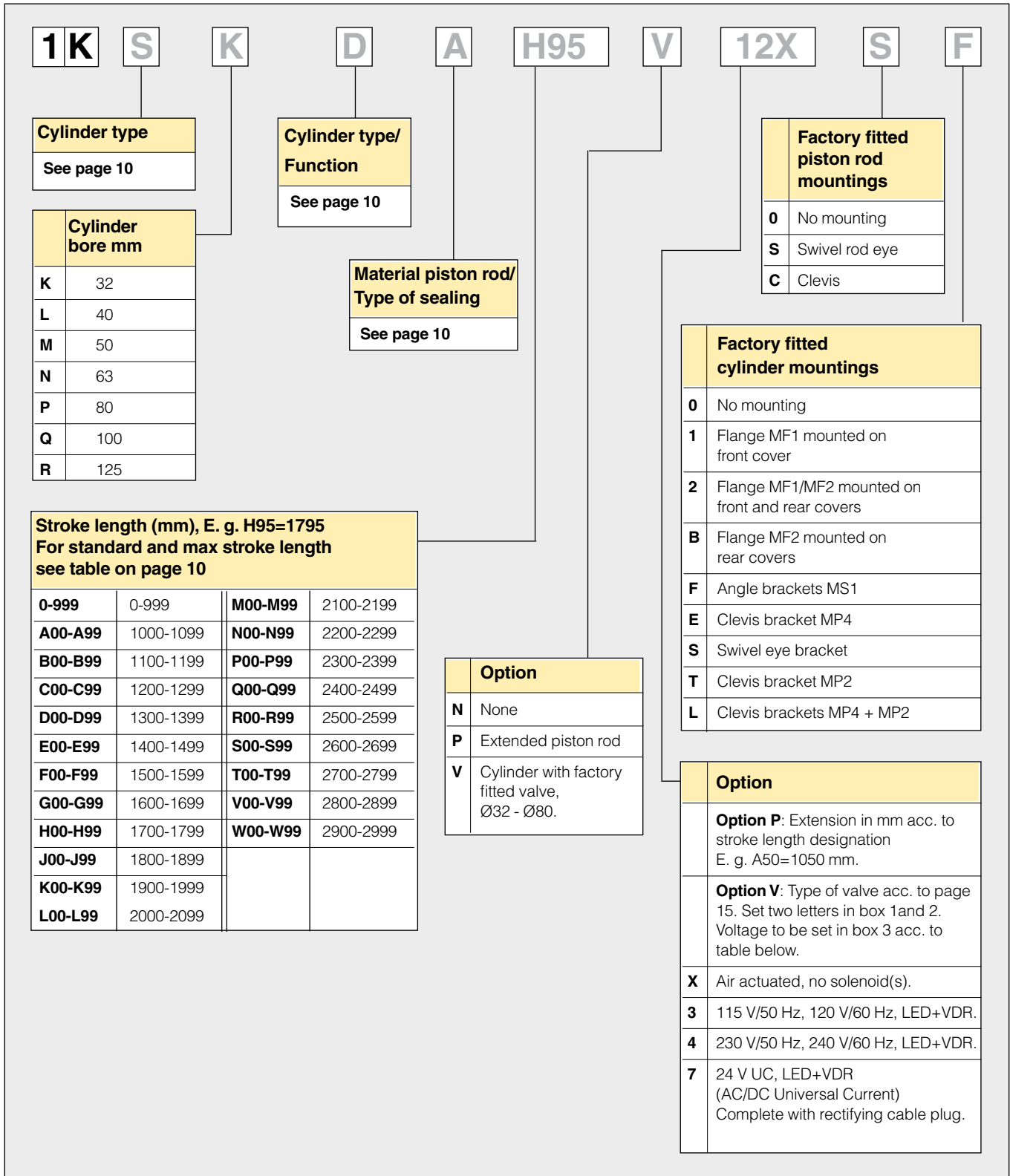

1K

Cylinder type
See page 10

Cylinder bore mm	
K	32
L	40
M	50
N	63
P	80
Q	100
R	125

Stroke length (mm), E. g. H95=1795
For standard and max stroke length see table on page 10

0-999	0-999	M00-M99	2100-2199
A00-A99	1000-1099	N00-N99	2200-2299
B00-B99	1100-1199	P00-P99	2300-2399
C00-C99	1200-1299	Q00-Q99	2400-2499
D00-D99	1300-1399	R00-R99	2500-2599
E00-E99	1400-1499	S00-S99	2600-2699
F00-F99	1500-1599	T00-T99	2700-2799
G00-G99	1600-1699	V00-V99	2800-2899
H00-H99	1700-1799	W00-W99	2900-2999
J00-J99	1800-1899		
K00-K99	1900-1999		
L00-L99	2000-2099		

S

**Cylinder type/
Function**
See page 10

K

**Material piston rod/
Type of sealing**
See page 10

D

A

Option	
N	None
P	Extended piston rod
V	Cylinder with factory fitted valve, Ø32 - Ø80.

H95

V

Factory fitted piston rod mountings	
0	No mounting
S	Swivel rod eye
C	Clevis

12X

Factory fitted cylinder mountings	
0	No mounting
1	Flange MF1 mounted on front cover
2	Flange MF1/MF2 mounted on front and rear covers
B	Flange MF2 mounted on rear covers
F	Angle brackets MS1
E	Clevis bracket MP4
S	Swivel eye bracket
T	Clevis bracket MP2
L	Clevis brackets MP4 + MP2

S

Option	
Option P: Extension in mm acc. to stroke length designation E. g. A50=1050 mm.	
Option V: Type of valve acc. to page 15. Set two letters in box 1 and 2. Voltage to be set in box 3 acc. to table below.	
X	Air actuated, no solenoid(s).
3	115 V/50 Hz, 120 V/60 Hz, LED+VDR.
4	230 V/50 Hz, 240 V/60 Hz, LED+VDR.
7	24 V UC, LED+VDR (AC/DC Universal Current) Complete with rectifying cable plug.

F

Order key

Option V: P1K cylinder with factory-fitted valve, (Ø32 - Ø80)				
Valve type	Symbol Ø32 - Ø80	Actuator	Return	Valve type and function
12		Air	Air	5/2 Signal pressure min 1,5 bar at 6 bar
13		Air	Spring	5/2 Signal pressure min 3,2 bar at 6 bar
14		Air	Self centring	5/3 Signal pressure min 3,8 bar at 6 bar Closed centre position
15		Air	Self centring	5/3 Signal pressure min 3,8 bar at 6 bar Vented centre position
16		Air	Self centring	5/3 Signal pressure min 3,8 bar at 6 bar Pressurised centre position
17		Electric	Electric	5/2 Internal supply to solenoid valve(s) via port 1
18		Electric	Spring	5/2 Internal supply to solenoid valve(s) via port 1
19		Electric	Electric	5/2 External supply to solenoid valve(s)
20		Electric	Spring	5/2 External supply to solenoid valve(s)
21		Electric	Self centring	5/3 Internal supply to solenoid valve(s) via port 1 Closed centre position
22		Electric	Self centring	5/3 External supply to solenoid valve(s) Closed centre position
23		Electric	Self centring	5/3 Internal supply to solenoid valve(s) via port 1 Vented centre position
24		Electric	Self centring	5/3 External supply to solenoid valve(s) Vented centre position
25		Electric	Self centring	5/3 Internal supply to solenoid valve(s) via port 1 Pressurised centre position
26		Electric	Self centring	5/3 External supply to solenoid valve(s) Pressurised centre position

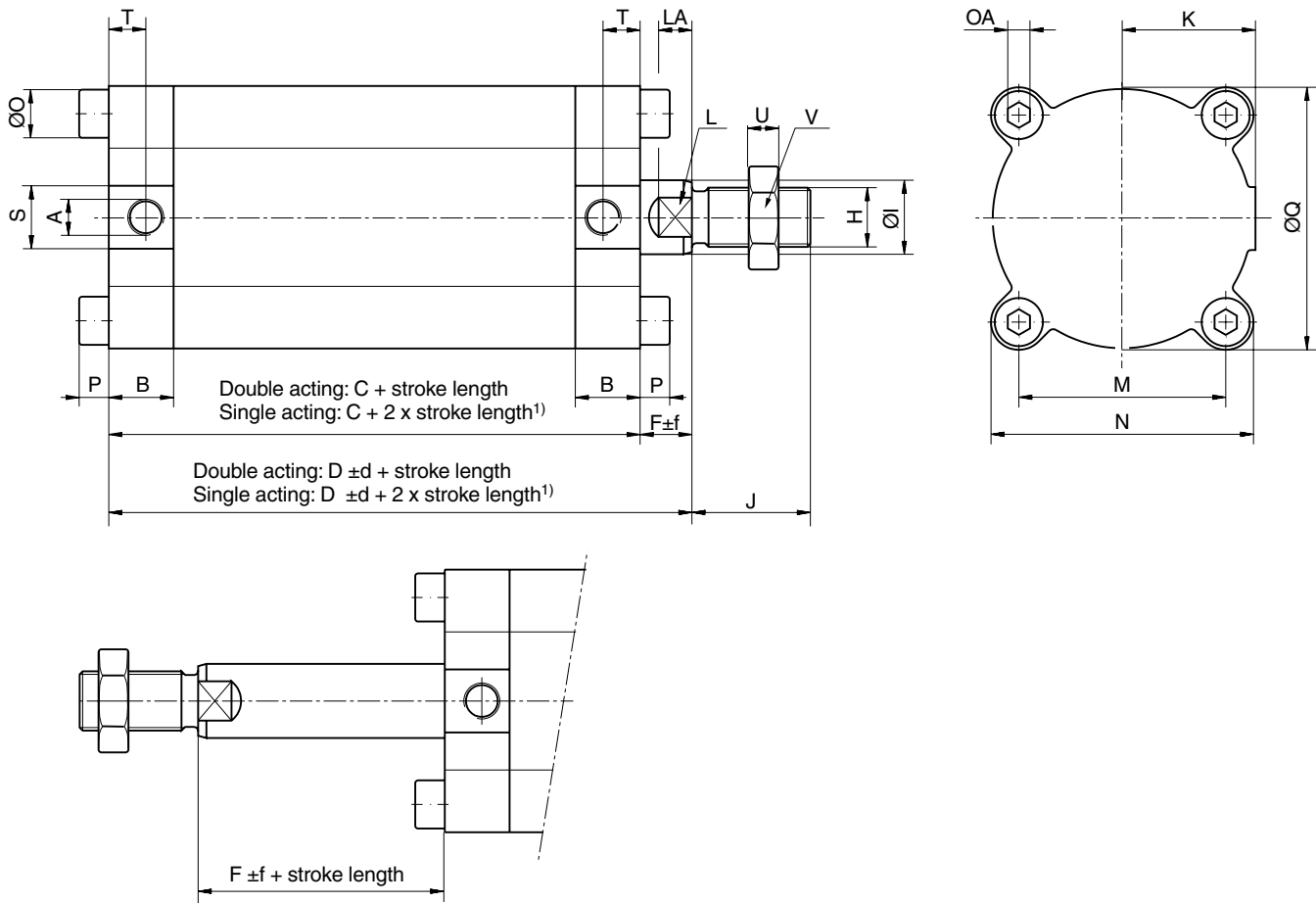

Dimensions

Cylinder designation	A	B	C	D	F	H	I	J	K	L	LA	M	N	O	OA	P	Q	S
		mm	mm	mm	mm			mm	mm	mm	mm	mm	mm	mm	mm	mm	mm	mm
P1K-S032	G1/8	17,0	65,0	75,0	10	M10x1,25	12	22	21,0	10	6	32,5	42,5	8,5	4	5	37	17
P1K-S040	G1/8	17,0	65,0	78,0	13	M12x1,25	16	24	24,0	14	9	36,8	48,0	10,0	5	6	45	17
P1K-S050	G1/8	17,5	71,0	85,0	14	M16x1,5	20	32	29,0	17	9	46,7	59,0	10,0	5	6	56	17
P1K-S063	G1/8	17,5	72,0	86,0	14	M16x1,5	20	32	36,0	17	9	55,9	71,0	13,0	6	8	70	17
P1K-S080	G1/4	21,5	85,0	101,0	16	M20x1,5	25	40	44,5	22	10	70,0	87,0	16,0	8	10	87	21
P1K-S100	G1/4	21,5	87,0	108,0	21	M20x1,5	32	40	55,0	27	13	84,1	102,0	16,0	8	10	108	21
P1K-S125	G3/8	25,5	94,5	115,5	21	M27x2	32	54	68,0	27	13	104,0	124,0	18,0	10	12	134	25

Dimensions

Cylinder designation	T	U	V
	mm	mm	mm
P1K-S032	10	5,0	17
P1K-S040	10	6,0	19
P1K-S050	10	8,0	24
P1K-S063	10	8,0	24
P1K-S080	12	10,0	30
P1K-S100	12	10,0	30
P1K-S125	14	13,5	41

Tolerances

Dimensions D and F	Stroke length
d	0-320 mm (at 6 bar)
f	mm
mm	mm
0,9	+2,0
1,2	+2,0
1,2	+2,0
1,2	+2,5
1,6	+2,5
1,2	+2,5
1,6	+2,5
1,2	+2,5
1,6	+2,5

1) Stroke length for dimensions 32-63 = 25 and 50 mm, for dimensions 80-100 = 50 mm.

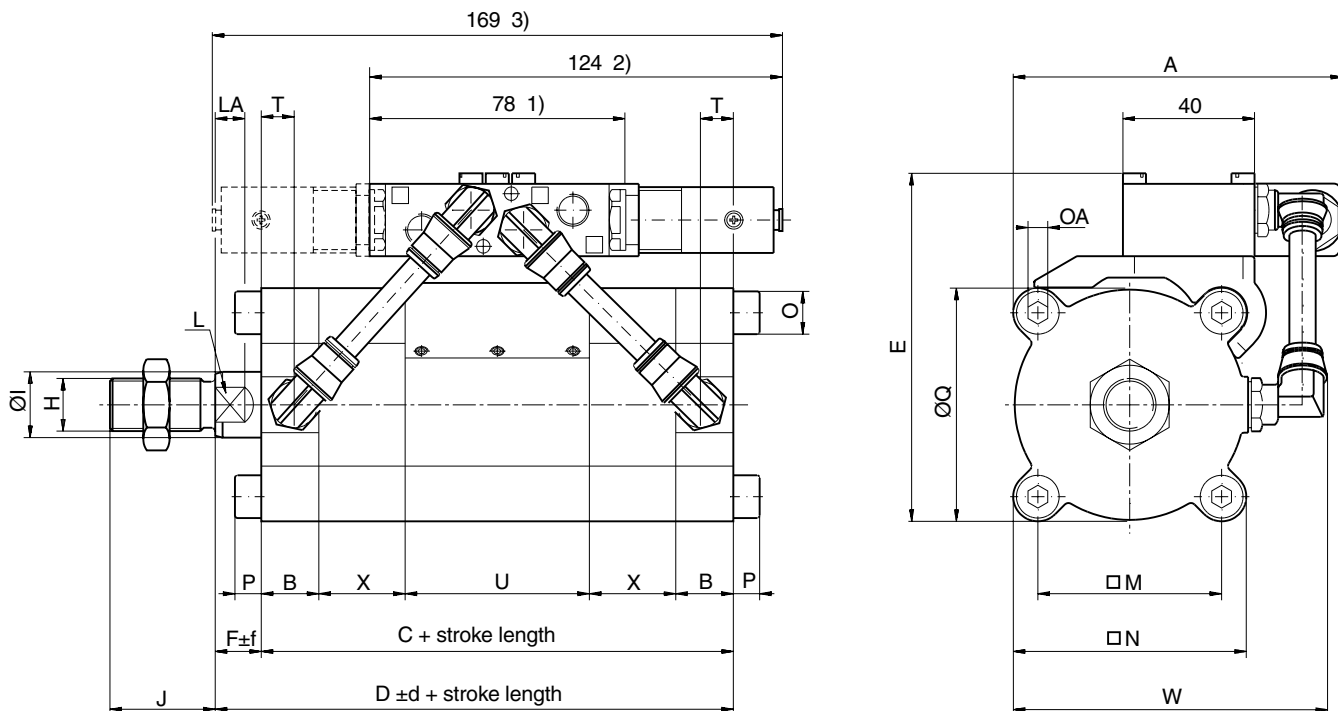

Dimensions

Cyl. bore. valve mm	A mm	B mm	C mm	D mm	E mm	F mm	H	I mm	J mm	L mm	LA mm	M mm	N mm	O mm	OA mm	P mm
332 P2L-A	76,0	17,0	65	75	76,5	10	M10x1,25	12	22	10	6	32,5	42,5	8,5	4	5
40 P2L-A	81,0	17,0	65	78	82,0	13	M12x1,25	16	24	14	9	36,8	48,0	10,0	5	6
50 P2L-A	94,0	17,5	71	85	94,0	14	M16x1,5	20	32	17	9	46,7	59,0	10,0	5	6
63 P2L-A	105,5	17,5	72	86	106,0	14	M16x1,5	20	32	17	9	55,9	71,0	13,0	6	8
80 P2L-A	119,0	21,5	85	101	122,0	16	M20x1,5	25	40	22	10	70,0	87,0	16,0	8	10

Dimensions

Cyl. bore. valve mm	Q mm	T mm	U mm	W mm	X mm
32 P2L-A	37	10	36	62,5	$-2,5 + \text{stroke length}/2$
40 P2L-A	45	10	36	69,5	$-2,5 + \text{stroke length}/2$
50 P2L-A	56	10	56	80,0	$-10,0 + \text{stroke length}/2$
63 P2L-A	70	10	56	94,0	$-9,5 + \text{stroke length}/2$
80 P2L-A	87	12	56	111,0	$-7,0 + \text{stroke length}/2$

Tolerances

Dimensions D and F d mm	f mm	Stroke length 0-320 mm (at 6 bar) mm
0,9	1,2	+2,0
0,9	1,2	+2,0
0,9	1,2	+2,0
1,2	1,6	+2,5
1,2	1,6	+2,5

1) 5/2 air/air and air/spring, 5/3 air/air
 2) 5/2 el/spring
 3) 5/2 el/el, 5/3 el/el
 Other dimensions according to P1K-S page 16.

Cylinder mountings

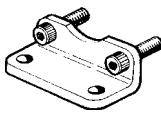
Type	Description	Cyl. bore Ø mm	Weight kg	Order code
Foot bracket MS1 	Intended for fixed mounting of cylinder. This bracket can be fitted to front and rear end covers. Material Body galvanized steel. These brackets are supplied in pairs. When fitting: <i>Remove the bolts from the cylinder end cover and fit the bracket, using the same bolts. The bolts supplied with the mount are intended for use with another range of cylinders and must not be used with the P1K range.</i>	32	0,08	9121644801
		40	0,11	9121644802
		50	0,18	9121644803
		63	0,26	9121644804
		80	0,50	9121644805
		100	0,80	9121644806
		125	1,40	9121644807

Cyl. Ø mm	A mm	B mm	C mm	D mm	E mm	F mm	G mm	H mm	I mm	K mm
32	48	32	5,0	32	53	7	24	32	113,0	99,0
40	54	36	5,0	36	60	9	31	42	127,0	109,0
50	64	45	6,0	45	75	9	33	45	137,0	118,0
63	76	50	6,0	50	86	9	36	48	144,0	122,0
80	94	63	8,0	63	107	12	43	58	171,0	144,0
100	110	75	10,5	71	122	14	43	60	173,0	151,0
125	135	90	12,5	90	157	16	45	70	184,5	160,5

S=stroke length

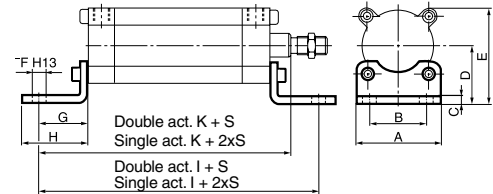

Flange MF1 and MF2

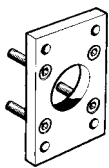

Intended for fixed mounting of cylinder. This bracket can be fitted to front and rear end covers.

Material
Diam. 32 - 63 mm: flange anodised aluminium
Diam. 80 - 125 mm: flange galvanized steel
The flange is supplied complete with screws for mounting on the cylinder.

32	0,26	9121644901
40	0,37	9121644902
50	0,52	9121644903
63	0,90	9121644904
80	1,59	9121644905
100	2,19	9121644906
125	3,90	9121644907

When fitting:
Remove the bolts from the cylinder end cover and fit the bracket, using the same bolts. The bolts supplied with the mount are intended for use with another range of cylinders and must not be used with the P1K range.

Cyl. Ø mm	A mm	B mm	C mm	D mm	E mm	F mm	G mm	H mm	I mm
32	80	64	48	32	7	10	0	86,0	27
40	90	72	54	36	9	13	0	91,0	32
50	110	90	64	45	9	13	1	98,0	40
63	120	100	76	50	9	16	-2	102,0	40
80	155	126	94	63	12	18	-2	119,0	50
100	180	150	110	75	14	18	3	126,0	60
125	220	180	135	90	16	20	1	135,5	72

S=stroke length

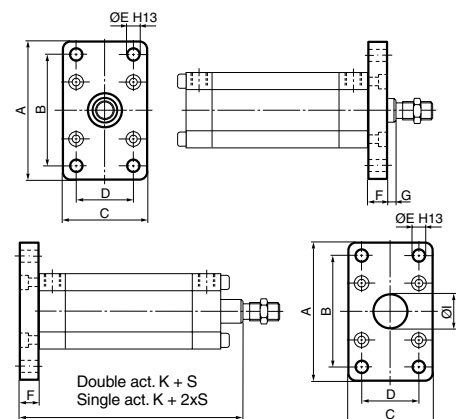

Cylinder mountings

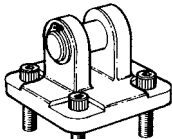
Type	Description	Cyl. bore Ø mm	Weight kg	Order code
Clevis bracket MP4 	Intended for flexible mounting of cylinder. This bracket can be combined with clevis bracket MP2 and swivel rod bracket. Materials: Body anodised aluminium and shaft of hardened steel. The mount is supplied complete with shaft. When fitting: Remove the bolts from the cylinder end cover and fit the mount, using the same bolts. The bolts supplied with the mount are intended for use with another range of cylinders and must not be used with the P1K range.	32	0,05	9121644601
		40	0,13	9121644602
		50	0,18	9121644603
		63	0,34	9121644604
		80	0,57	9121644605
		100	0,91	9121644606
		125	2,90	9121644607

Cyl. Ø mm	A mm	B mm	C mm	D mm	E mm	F mm	G mm	H mm	I mm	K mm
32	48	22	33	26	10	10	11	15,0	22	97,0
40	54	24	35	28	12	12	12	21,0	28	106,0
50	64	32	39	32	12	12	13	19,5	28	113,0
63	76	39	47	40	16	16	17	26,0	36	122,0
80	94	48	57	50	16	16	17	26,0	38	139,0
100	110	62	67	60	20	20	21	29,0	43	151,0
125	135	70	77	70	25	25	26	35,0	50	165,5

S=stroke length

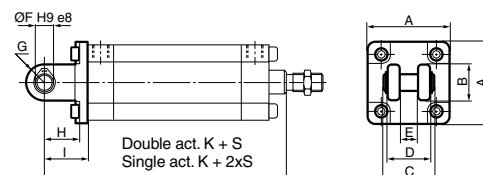

Clevis bracket MP2

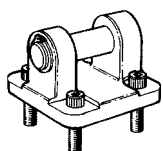

Intended for flexible mounting of cylinder. This bracket can be combined with clevis bracket MP4.

Materials:
Body anodised aluminium and shaft of hardened steel.
The mount is supplied complete with shaft.

When fitting:

Remove the bolts from the cylinder end cover and fit the mount, using the same bolts. The bolts supplied with the mount are intended for use with another range of cylinders and must not be used with the P1K range.

32	0,13	9121644701
40	0,19	9121644702
50	0,22	9121644703
63	0,40	9121644704
80	0,65	9121644705
100	1,09	9121644706
125	3,60	9121644707

Cyl. Ø mm	A mm	B mm	C mm	D mm	E mm	F mm	G mm	H mm	I mm	K mm
32	48	22	52	45	26	10	11	15,0	22	97,0
40	54	24	59	52	28	12	12	21,0	28	106,0
50	64	32	67	60	32	12	13	19,5	28	113,0
63	76	39	77	70	40	16	17	26,0	36	122,0
80	94	48	97	90	50	16	17	26,0	38	139,0
100	110	62	117	110	60	20	21	29,0	43	151,0
125	135	70	137	130	70	25	26	35,0	50	165,5

S=stroke length

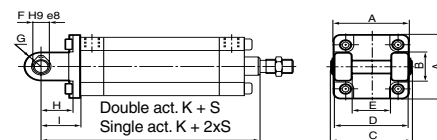

Swivel rod bracket

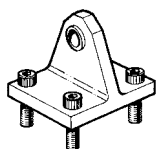

Intended for flexible mounting of cylinder. The swivel rod permits lateral articulation. The bracket can be combined with clevis bracket MP4

Materials:
Body anodised aluminium and swivel bearing of hardened steel.

When fitting:

Remove the bolts from the cylinder end cover and fit the mount, using the same bolts. The bolts supplied with the mount are intended for use with another range of cylinders and must not be used with the P1K range.

32	0,08	9121568601
40	0,12	9121568602
50	0,17	9121568603
63	0,30	9121568604
80	0,49	9121568605
100	0,73	9121568606
125	2,40	9121568607

Cyl. Ø mm	A mm	B mm	C mm	D mm	F mm	G mm	H mm	I mm	K mm
32	48	9	7,5	13,0	10	12,5	15,0	22	97,0
40	54	12	9,0	15,5	12	15,5	21,0	28	106,0
50	64	12	9,0	15,5	12	16,5	19,5	28	113,0
63	76	16	12,5	20,0	16	19,5	26,0	36	122,0
80	94	16	12,5	20,0	16	21,5	26,0	38	139,0
100	110	20	16,0	25,0	20	25,5	29,0	43	151,0
125	135	25	20,5	30,5	25	30,0	35,0	50	165,5

S=stroke length

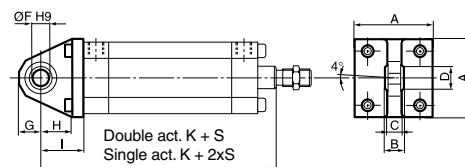

Piston rod mountings

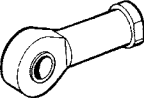
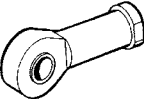
Type	Description	Cyl. bore Ø mm	Weight kg	Order code
Swivel rod eye 	Intended for articulated mounting of the cylinder. Maintenance-free PTFE. Material: Swivel rod eye, nut: galvanized steel. Swivel bearing according to DIN 648K: Hardened steel.	32	0,08	P1C-4KRS P1C-4LRS P1C-4MRS P1C-4MRS P1C-4PRS P1C-4PRS P1C-4RRS
		40	0,12	
		50	0,25	
		63	0,25	
		80	0,46	
		100	0,46	
		125	1,28	
Stainless steel swivel rod eye 	Stainless-steel swivel rod eye for articulated mounting of cylinder. Maintenance-free. Materials Swivel rod eye: Stainless steel Swivel bearing according to DIN 648K: Stainless steel Use stainless steel nut (see page 21) with stainless steel swivel rod eye.	32	0,08	P1S-4JRT P1S-4LRT P1S-4MRT P1S-4MRT P1S-4MRT P1S-4PRT P1S-4PRT P1S-4RRT
		40	0,12	
		50	0,25	
		63	0,25	
		80	0,46	
		100	0,46	
		125	1,28	

ISO 8139

Cyl.- dia. mm	A mm	B min mm	B max mm	CE mm	CN H9 mm	EN h12 mm	ER mm	KK mm	LE min mm	N* mm	O mm	Z °
32	20	48,0	55	43	10	14	14	M10x1,25	15	17	10,5	12°
40	22	56,0	62	50	12	16	16	M12x1,25	17	19	12,0	12°
50	28	72,0	80	64	16	21	21	M16x1,5	22	22	15,0	15°
63	28	72,0	80	64	16	21	21	M16x1,5	22	22	15,0	15°
80	33	87,0	97	77	20	25	25	M20x1,5	26	32	18,0	15°
100	33	87,0	97	77	20	25	25	M20x1,5	26	32	18,0	15°
125	51	123,5	137	110	30	37	35	M27x2	36	41	25,0	15°

*key grip

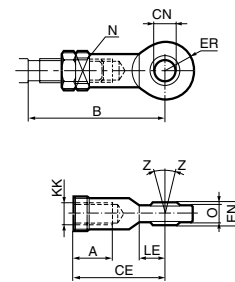

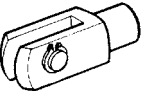
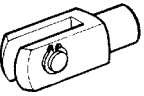
Clevis 	Intended for articulated mounting of the cylinder. Material: Clevis and clip galvanized steel. Pin: Hardened steel Supplied complete with axle.	32	0,09	P1C-4KRC P1C-4LRC P1C-4MRC P1C-4MRC P1C-4PRC P1C-4PRC P1C-4RRC
		40	0,15	
		50	0,35	
		63	0,35	
		80	0,75	
		100	0,75	
		125	2,10	
Stainless steel clevis 	Stainless-steel clevis for articulated mounting of cylinder. Material Clevis: Stainless steel Pin: Stainless steel Circlips according to DIN 471: Stainless steel Use stainless steel nut (see page 21) with stainless steel swivel rod eye.	32	0,09	P1S-4JRD P1S-4LRD P1S-4MRD P1S-4MRD P1S-4MRD P1S-4PRD P1S-4PRD P1S-4RRD
		40	0,15	
		50	0,35	
		63	0,35	
		80	0,75	
		100	0,75	
		125	2,10	

ISO 8140

Cyl.- dia. mm	A mm	B min mm	B max mm	CE mm	CK h11/E9 mm	CL mm	CM mm	ER mm	KK mm	LE mm	O mm
32	20	45,0	52	40	10	20	10	16	M10x1,25	20	28,0
40	24	54,0	60	48	12	24	12	19	M12x1,25	24	32,0
50	32	72,0	80	64	16	32	16	25	M16x1,5	32	41,5
63	32	72,0	80	64	16	32	16	25	M16x1,5	32	41,5
80	40	90,0	100	80	20	40	20	32	M20x1,5	40	50,0
100	40	90,0	100	80	20	40	20	32	M20x1,5	40	50,0
125	56	123,5	137	110	30	55	30	45	M27x2	54	72,0

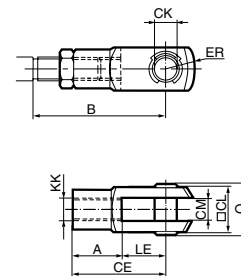

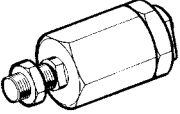

Piston rod mountings

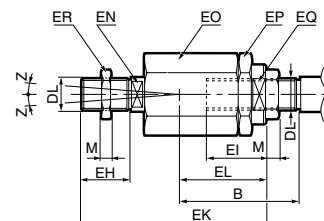
Type	Description	Cyl. bore Ø mm	Weight kg	Order code
Flexo coupling 	Flexo coupling for articulated mounting of piston rod.	32	0,21	P1C-4KRF P1C-4LRF P1C-4MRF P1C-4MRF P1C-4PRF P1C-4PRF P1C-4RRF
	Flexo fitting is intended to take up axial angle errors within a range of ±4°.	40	0,22	
		50	0,67	
		63	0,67	
	Material	80	0,72	
	Flexo coupling, nut: Zinc-plated steel	100	0,72	
Socket: Hardened steel	125	1,80		
	Supplied complete with galvanized adjustment nut.			



Cyl.-bore mm	B min mm	B max mm	DL	EH	EI	EK	EL	EN	EO	EP	EQ	ER	M	Z
32	36,0	43	M10x1,25	20	23	70	31	12	30	30	19	30	5,0	4°
40	37,0	43	M12x1,25	23	23	67	31	12	30	30	19	30	6,0	4°
50	53,0	61	M16x1,5	40	32	112	45	19	41	41	30	41	8,0	4°
63	53,0	61	M16x1,5	40	32	112	45	19	41	41	30	41	8,0	4°
80	57,0	67	M20x1,5	39	42	122	56	19	41	41	30	41	10,0	4°
100	57,0	67	M20x1,5	39	42	122	56	19	41	41	30	41	10,0	4°
125	75,5	89	M27x2	48	48	145	60	24	55	55	32	55	13,5	4°

Piston rod nut 	Intended for fixed mounting of accessories to the piston rod.	32	0,007	9128985601 0261109910 9128985603 9128985603 0261109911 0261109911 0261109912
	Material: Zinc-plated steel	40	0,010	
		50	0,021	
		63	0,021	
		80	0,040	
	The cylinders are supplied complete with one zinc plated steel piston rod nut.	100	0,040	
	125	0,100		
Stainless steel nut 	Intended for fixed mounting of accessories to the piston rod.	32	0,007	9126725404 9126725405 9126725406 9126725406 0261109921 0261109921 0261109922
	Material: Stainless steel A2	40	0,010	
		50	0,021	
		63	0,021	
		80	0,040	
	The cylinders are supplied complete with one zinc plated steel piston rod nut.	100	0,040	
	125	0,100		
Acid-proof nut 	Intended for fixed mounting of accessories to the piston rod.	32	0,007	0261109919 0261109920 0261109917 0261109917 0261109916 0261109916 0261109918
	Material: Acid-proof steel A4	40	0,010	
		50	0,021	
		63	0,021	
		80	0,040	
	Cylinders with acid-proof piston rod are supplied with nut of acid-proof steel	100	0,040	
	125	0,100		

Enligt DIN 439 B

Cyl. Ø mm	A mm	B mm	C
32	17	5,0	M10x1,25
40	19	6,0	M12x1,25
50	24	8,0	M16x1,5
63	24	8,0	M16x1,5
80	30	10,0	M20x1,5
100	30	10,0	M20x1,5
125	41	13,5	M27x2

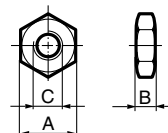

Combinations

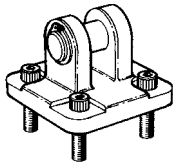
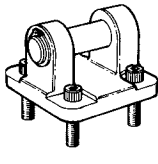
Type	Description	Cyl. bore Ø mm	Order code	Order code
Clevis bracket MP4	In this combination the clevis bracket MP4 is attached to the indicated cylinder.	32 40 50 63 80 100 125	MP4	MP2
				9121644601 9121644602 9121644603 9121644604 9121644605 9121644606 9121644607

Cyl. Ø mm	A mm	B mm	C mm	D mm	E mm	F mm	G mm	H mm	I mm	K mm	L
32	48	32,5	5,5	7,0	15,0	22	44	97,0	119,0	52	104°
40	54	36,8	6,6	7,0	21,0	28	56	106,0	134,0	59	130°
50	64	46,7	6,6	8,5	19,5	28	56	113,0	141,0	67	120°
63	76	55,9	9,0	10,0	26,0	36	72	122,0	158,0	77	110°
80	94	70,0	11,0	12,0	26,0	38	76	139,0	177,0	97	80°
100	110	84,1	11,0	14,0	29,0	43	86	146,0	189,0	117	82°
125	135	104,0	14,0	15,0	35,0	50	100	165,5	215,5	137	82°

S=stroke length

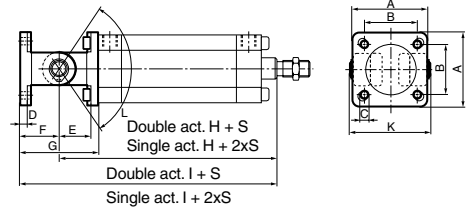

Swivel rod bracket

Clevis bracket MP4

In this combination the swivel rod bracket is attached to the indicated cylinder.

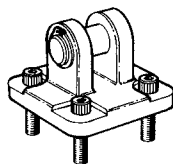
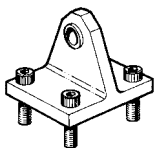

Cyl. bore Ø mm	Swivel rod bracket	MP4
32	9121568601	9121644601
40	9121568602	9121644602
50	9121568603	9121644603
63	9121568604	9121644604
80	9121568605	9121644605
100	9121568606	9121644606
125	9121568607	9121644607

Cyl. Ø mm	A mm	B mm	C mm	D mm	E mm	F mm	G mm	H mm	I mm	K mm	L
32	48	32,5	5,5	7,0	15,0	22	44	97,0	119,0	104°	5,7°
40	54	36,8	6,6	7,0	21,0	28	56	106,0	134,0	130°	5,5°
50	64	46,7	6,6	8,5	19,5	28	56	113,0	141,0	120°	5,2°
63	76	55,9	9,0	10,0	26,0	36	72	122,0	158,0	110°	5,1°
80	94	70,0	11,0	12,0	26,0	38	76	139,0	177,0	80°	4,6°
100	110	84,1	11,0	14,0	29,0	43	86	146,0	189,0	82°	4,4°
125	135	104,0	14,0	15,0	35,0	50	100	165,5	215,5	82°	4,4°

S=stroke length

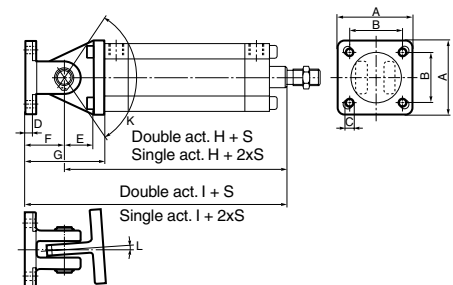

Tightening torques

When attaching mountings, the bolts should be tightened to the following torques.

If other types of mounting are used, the following maximum metal thicknesses apply when using the cylinder end cover bolts.

Cylinder bore mm	Tightening torque Nm	Maximum metal thickness mm
32	4,5±0,5	7,0
40	8±0,8	7,0
50	8±0,8	8,5
63	20±2	10,0
80	40±4	12,0
100	40±4	14,0
125	60±6	15,0

Seal kits for complete P1K cylinder

Cyl. bore mm	Option			
	Standard	High Temp.	Low Temp.	Hydraulic
32	9122352088	9122421921	P1K-6032PL	9122421931
40	9122352089	9122421922	P1K-6040PL	9122421932
50	9122352090	9122421923	P1K-6050PL	9122421933
63	9122352091	9122421924	P1K-6063PL	9122421934
80	9122352092	9122421925	P1K-6080PL	9122421935
100	9122352093	9122421926	P1K-6100PL	9122421936
125	9122352100	*	*	9122421937

* Please contact customer service.

Grease for P1K



Standard	30g	9127394541
High temperature	30g	9127394521
Low temperature	30g	9127394541

www.parker.com

Pneumatic Division Sales Offices

Austria - Wr.Neustadt
Tel: +43 2622 23501
Fax: +43 2622 66212

Norway - Langhus
Tel: +47 6491 1000
Fax: +47 6491 1090

Belgium - Nivelles
Tel: +32 67 280 900
Fax: +32 67 280 999

Poland - Warsaw
Tel: +48 22 573 24 00
Fax: +48 22 573 24 03

**Czech & Slovak
Republics - Klecany**
Tel: +420 284 083 111
Fax: +420 284 083 112

**Portugal - Leça da
Palmeira**
Tel: +351 22 999 7360
Fax: +351 22 996 1527

Denmark - Ballerup
Tel: +45 43 560400
Fax: +45 43 733107

Romania - Bucharest
Tel: +40 21 252 1382
Fax: +40 21 252 3381

Finland - Vantaa
Tel: +358 9 4767 31
Fax: +358 9 4767 3200

Russia - Moscow
Tel: +7 095 234 0054
Fax: +7 095 234 0528

France - Contamine
Tel : +33 4 50 25 80 25
Fax : +33 4 50 03 67 37

Slovenia - Novo mesto
Tel: +386 7337 6650
Fax: +386 7337 6651

Germany - Kaarst
Tel: +49 2131 4016-0
Fax: +49 2131 4016-9199

Spain - Madrid
Tel: +34 91 675 7300
Fax: +34 91 675 7711

Greece - Athens
Tel: +30 210 933 6450
Fax: +30 210 933 6451

Sweden - Spånga
Tel: +46 (0) 8 5979 5000
Fax: +46 (0) 8 5979 5120

Hungary - Budapest
Tel: +36 1 220 4155
Fax: +36 1 422 1525

Switzerland - Bolligen
Tel: +41 31 917 18 50
Fax: +41 31 917 18 59

Ireland - Dublin
Tel: +353 1 293 9999
Fax: +353 1 293 9999

Turkey - Istanbul
Tel: +90 212 482 91 06
Fax: +90 212 482 91 10

Italy - Corsico, Milan
Tel: +39 02 4519 21
Fax: +39 02 4479 340

UK - Warwick
Tel: +44 1926 317 878
Fax: +44 1926 317 855

Netherlands - Oldenzaal
Tel: +31 541 585000
Fax: +31 541 585459

Ukraine - Kiev
Tel: + 380 44 220 7432
Fax: + 380 44 220 6534



Parker Hannifin Ltd.
Pneumatic Division,
Walkmill Lane, Bridgtown,
Cannock, Staffs. WS11 0LR
United Kingdom

We reserve the right to make
alterations without prior notification.